



i d e **g** r a f
publicidad



**BANNERS, DEMO STAND, DISPLAYS,
FLAG BANNER & CARPAS**

otro punto de vista...



Descripción

Cuerpo:

Fabricado en aluminio,
Estructura Armable de 5 pzas

Accesorios:

4 varillas de Aluminio, Sujetadores de
Plástico, Centro y Maleta

Sustratos:

Lona, Tela Flack, Tela Sublimada y Mesh.

Rigidos:

Coroplas, Estireno y trovicel

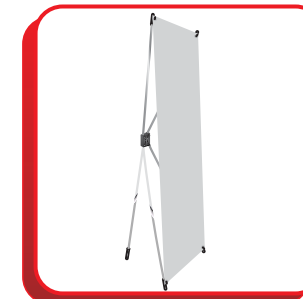
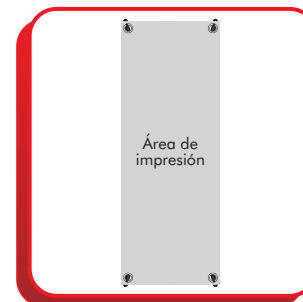

Medidas	
Base	Altura
60 cm	120 cm
60 cm	160 cm
70 cm	170 cm
80 cm	180 cm
100 cm	200 cm

*Medidas especial sobre pedido

Ensamble portabanner

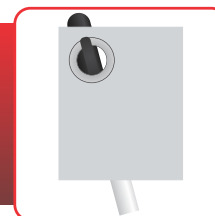
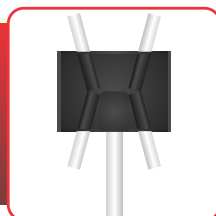
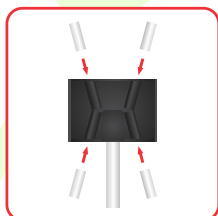

Sucursal: 4 SUR ESQ. CON 21 OTE
NO. 1922 LOCAL 1, COL. EL CARMEN
TEL: (222) 243 11 59

otro punto de vista...



Portabanner

Descripción

Cuerpo:

Fabricado en aluminio,
Estructura Armable de 3 pzas

Accesorios:

1 varilla de Aluminio, Base, Sujetador
de lona Superior y Maleta
de tela.

Sustratos:

Lona, Tela Flack, Tela Sublimada y Mesh.



Ensamble Roll up



Medidas

Base	Altura
22 cm	42 cm
80 cm	200 cm
85 cm	200 cm
150 cm	200 cm

*Medidas especial sobre pedido

Roll up

Sucursal: 4 SUR ESQ. CON 21 OTE
NO. 1922 LOCAL 1, COL. EL CARMEN
TEL: (222) 243 11 59

otro punto de vista...



Descripción

Cuerpo:

Fabricado de Aluminio, estructura abatible.

Accesorios:

Estructura plegable, Una estantería, Base de melamina, Sustrato, canaletas, copete de trovicel rotulado con vinil impreso y maleta de tela.

Sustratos:

Lona, Tela flack, Tela sublimada.

Área de Impresión

Base	Altura
137 cm	91 cm
Copete	
Base	Altura
50 cm	30 cm

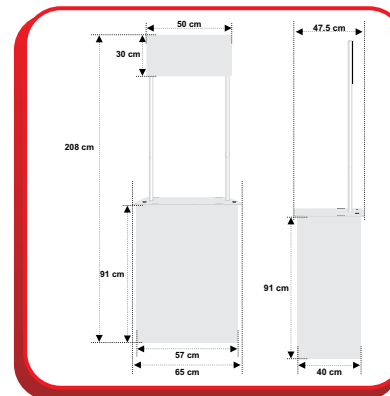

Ensamble demo pequeño

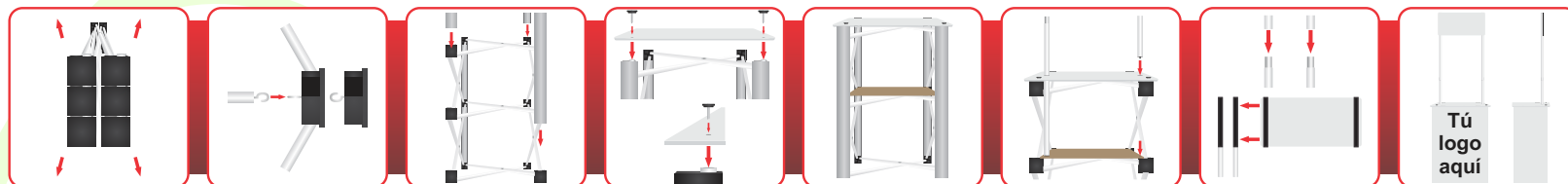

Sucursal: 4 SUR ESQ. CON 21 OTE
NO. 1922 LOCAL 1, COL. EL CARMEN
TEL: (222) 243 11 59

otro punto de vista...



Demo Stand Pequeño



Descripción

Cuerpo:

Fabricado de trovichel y canales de aluminio con mesa de madera con perforaciones .

Accesorios:

Fabricado en trovichel con marcos de aluminio, cuenta con un copete formando un rectángulo y en la parte trasera interna tiene una repisa. Fácil y rápido proceso de armado. Incluye maleta transportadora..

Tipo de impresión:

Impresión digital vinil impreso full color, alta resolución

Área de Impresión	
Base	Altura
137 cm	91 cm
Copete	
Base	Altura
50 cm	30 cm

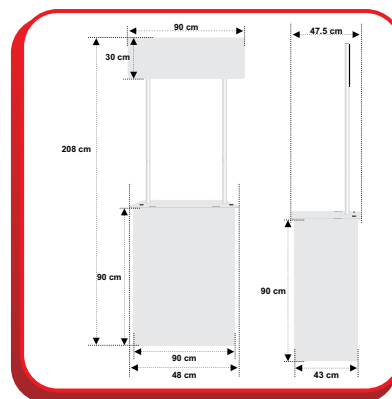

Ensamble demo Plastico

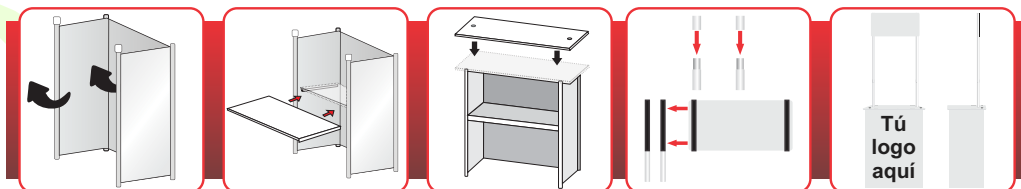

Sucursal: 4 SUR ESQ. CON 21 OTE
NO. 1922 LOCAL 1, COL. EL CARMEN
TEL: (222) 243 11 59

otro punto de vista...



Descripción

Cuerpo:

Aluminio abatible.

Accesorios:

Estructura plegable, Una estantería, Base de melamina, sustrato, canaletas, copete de trovicel rotulado con vinil impreso y maleta de tela.

Sustratos:

Lona, Vinil impreso, Tela flack y Tela sublimada.

Área de Impresión

Base	Altura
164 cm	91 cm
Copete	
Base	Altura
100 cm	30 cm

*Medidas especial sobre pedido



Ensamble stand eco



Sucursal: 4 SUR ESQ. CON 21 OTE
NO. 1922 LOCAL 1, COL. EL CARMEN
TEL: (222) 243 11 59

otro punto de vista...



Demo Stand Eco

Descripción

Cuerpo:

Estructura de Aluminio abatible.

Accesorios:

Estructura plegable, Una estantería, Base de melamina, Sustrato, canaletas, copete de trovicel rotulado con vinil impreso y maleta de tela.

Sustratos:

Lona, Tela flack, Tela sublimada.

Área de Impresión

Base	Altura
172 cm	91 cm

Copete

Base	Altura
100 cm	30 cm

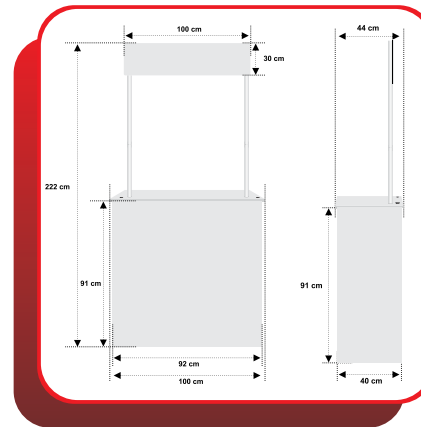

Ensamble stand refor

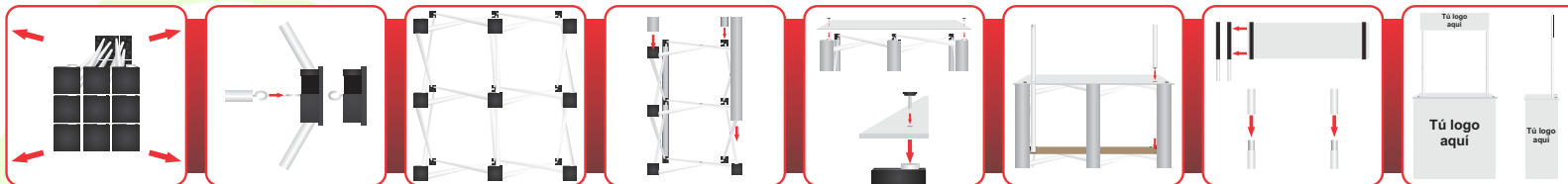

Sucursal: 4 SUR ESQ. CON 21 OTE
NO. 1922 LOCAL 1, COL. EL CARMEN
TEL: (222) 243 11 59

otro punto de vista...



Demo Stand Refor

Descripción

Cuerpo:

Estructura de Aluminio abatible.

Accesorios:

Estructura plegable, Una estantería,
Base de melamina, sustrato, canaletas
y maleta de tela.

Sustratos:

Lona, Tela flack, Tela sublimada.



Área de Impresión

Base	Altura
226 cm	91 cm

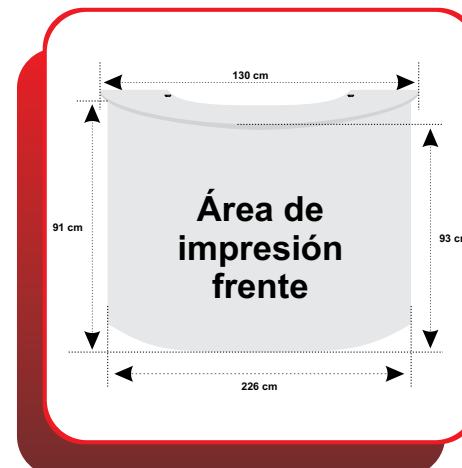

Ensamble stand media luna

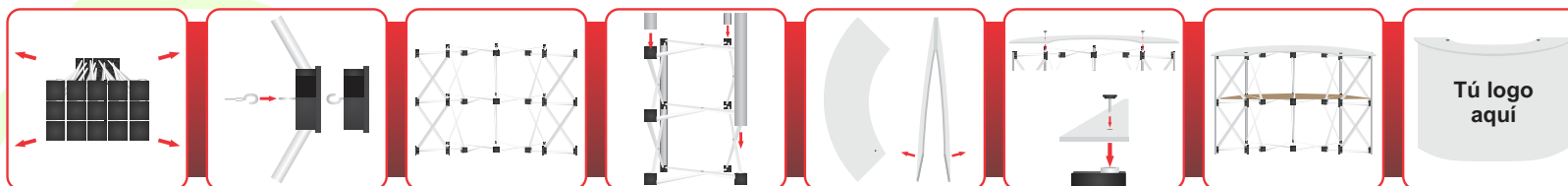

Sucursal: 4 SUR ESQ. CON 21 OTE
NO. 1922 LOCAL 1, COL. EL CARMEN
TEL: (222) 243 11 59

otro punto de vista...



Descripción

Cuerpo:

Estructura de Aluminio abatible.

Accesorios:

Una estantería, Base de melamina, sustrato, canaletas y maleta de tela.

Sustratos:

Lona, Tela flack, Tela sublimada.



Área de Impresión

Base	Altura
104 cm	91 cm

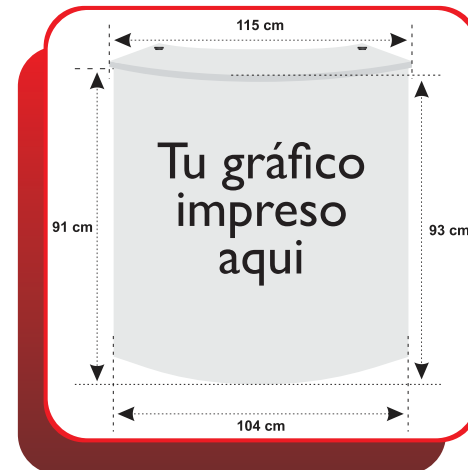

Ensamble stand cuarto luna

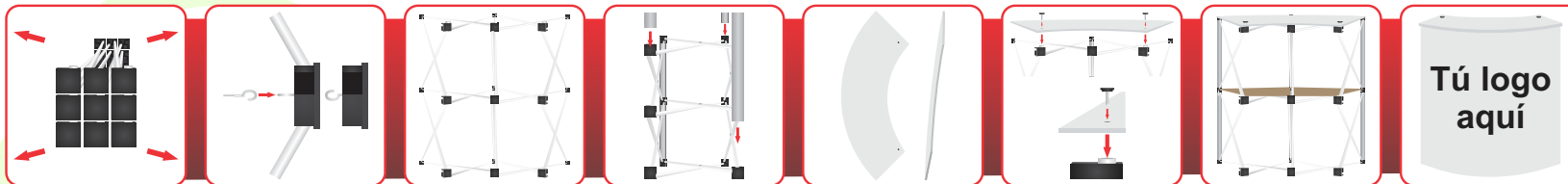

Sucursal: 4 SUR ESQ. CON 21 OTE
NO. 1922 LOCAL 1, COL. EL CARMEN
TEL: (222) 243 11 59

otro punto de vista...



Demo Cuarto luna



Descripción

Cuerpo:

Estructura de Aluminio abatible.

Accesorios:

Estructura plegable, sustrato y maleta de tela

Sustratos:

Lona, Tela flack, Tela sublimada.

Área de Impresión

Base	Altura
292 cm	220 cm

Medidas

Base	Altura
76 cm	219 cm
148 cm	219 cm
210 cm	170 cm
80 cm	180 cm
100 cm	200 cm

*Medidas especial sobre pedido

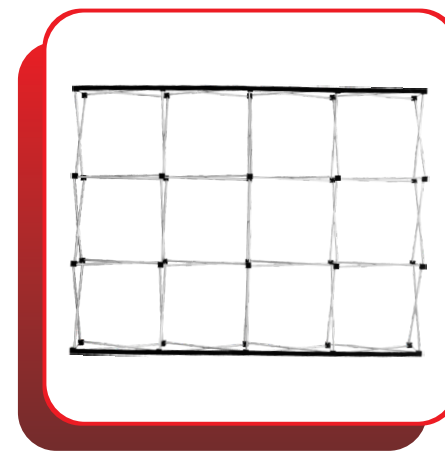
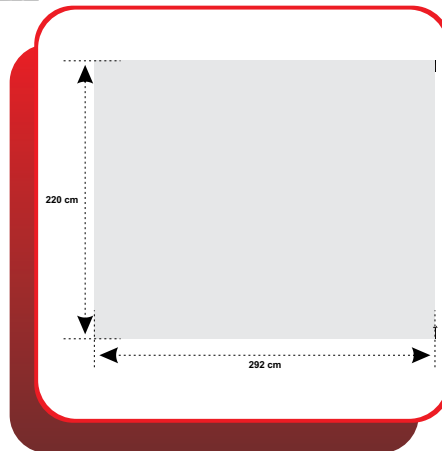

Ensamble stand pop up

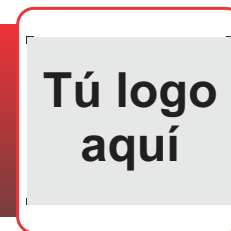
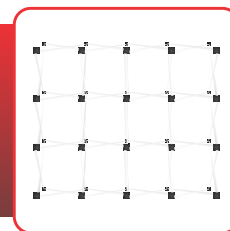
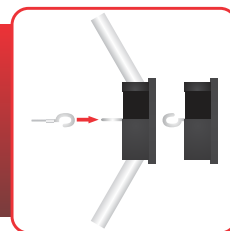
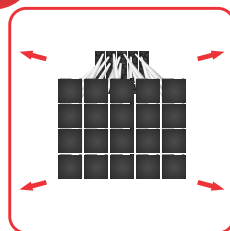

Tú logo
aquí

Sucursal: 4 SUR ESQ. CON 21 OTE
NO. 1922 LOCAL 1, COL. EL CARMEN
TEL: (222) 243 11 59

otro punto de vista...



Pop Up



Descripción

Cuerpo:
Estructura de Aluminio abatible.

Accesorios:
Estructura plegable, sustrato
y maleta de tela.

Sustratos:
Lona, Tela flack, Tela sublimada.

Área de Impresión	
Base	Altura
76 cm	220 cm

*Medidas especial sobre pedido la media puede ir variando ya sea con uno, dos, o tres paneles.

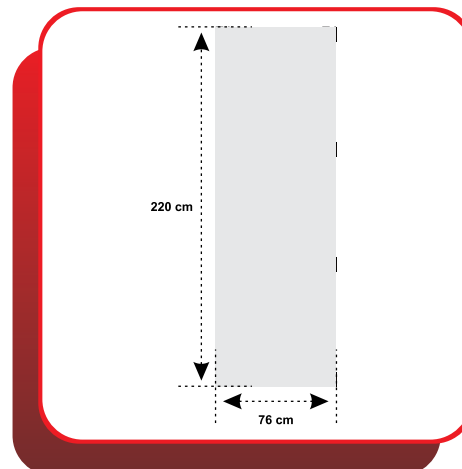
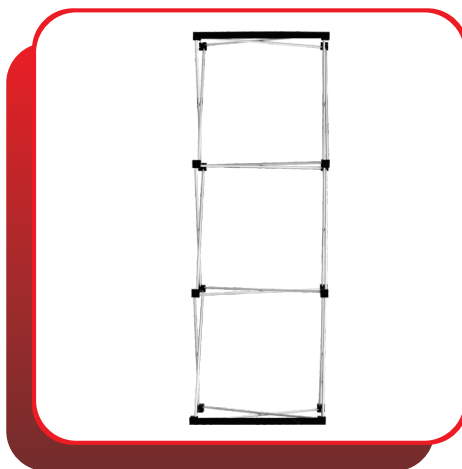

Ensamble stand pop up

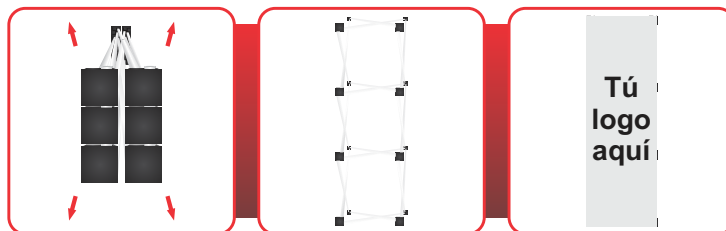

Sucursal: 4 SUR ESQ. CON 21 OTE
NO. 1922 LOCAL 1, COL. EL CARMEN
TEL: (222) 243 11 59

otro punto de vista...





Descripción

Cuerpo:

Estructura de Aluminio abatible.

Accesorios:

Estructura plegable, sustrato y maleta de tela

Sustratos:

Lona, Tela flack, Tela sublimada.

Área de Impresión

Base	Altura
277 cm	219 cm

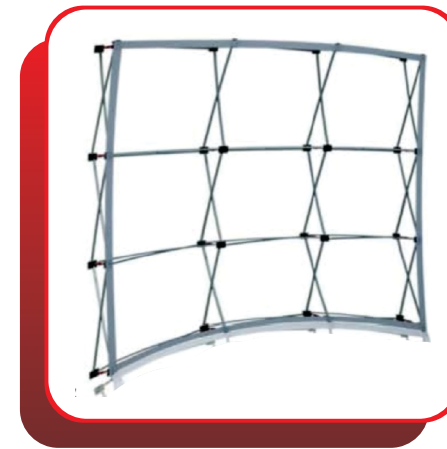
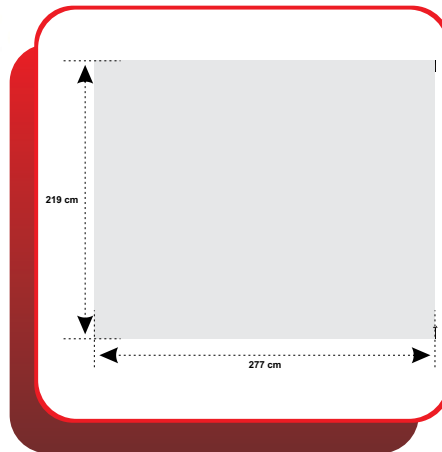

Ensamble stand pop up

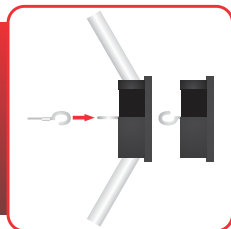
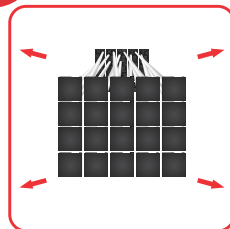

Sucursal: 4 SUR ESQ. CON 21 OTE
NO. 1922 LOCAL 1, COL. EL CARMEN
TEL: (222) 243 11 59

otro punto de vista...



Pop Up Semi Circukar

Descripción

Cuerpo:
Aluminio abatible.

Accesorios:
Estructura de Aluminio, maleta, sustrato,
base para piso o pasto e instructivo

Sustratos:
Lona, Tela flack, Tela sublimada, Tela
delgada.

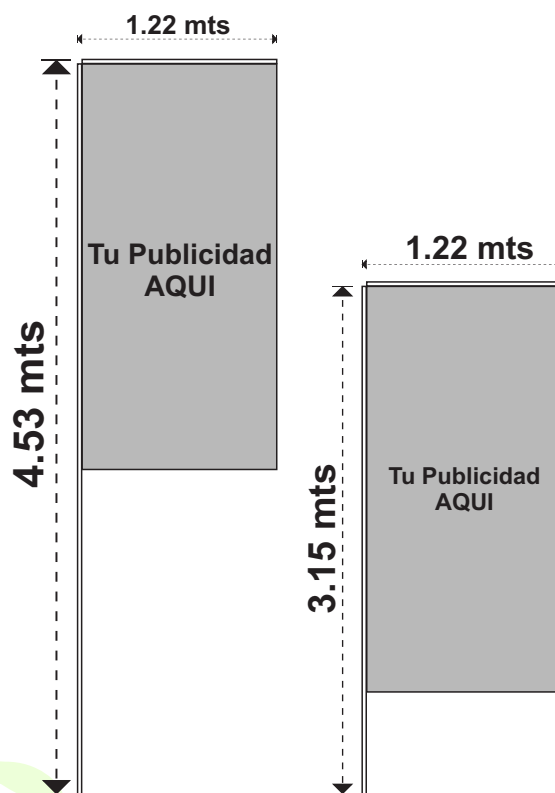

Medidas

Base	Altura
122 cm	315 cm
122 cm	453 cm

Ensamble

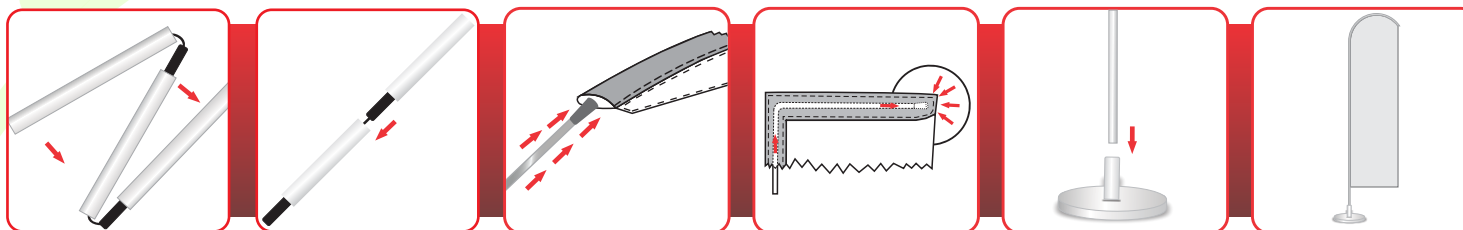

Sucursal: 4 SUR ESQ. CON 21 OTE
NO. 1922 LOCAL 1, COL. EL CARMEN
TEL: (222) 243 11 59

otro punto de vista...



1 Demo Flag Rectangulo

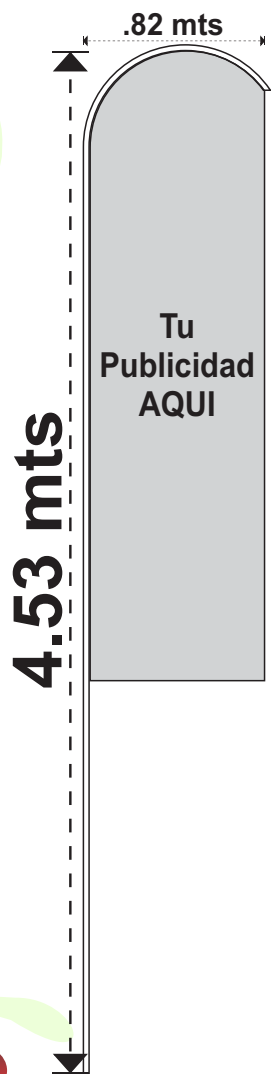
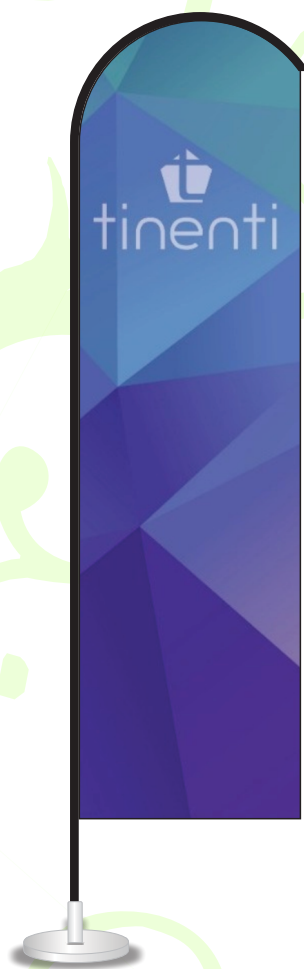

Descripción

Cuerpo:

Asta de aluminio, base metálica, tela 100% poliéster sublimada.

Accesorios:

Estructura de Aluminio, maleta, sustrato, base para piso o pasto e instructivo

Sustratos:

Lona, Tela flack, Tela sublimada, Tela delgada.

Medidas

Base	Altura
82 cm	315 cm
82 cm	453 cm

Ensamble

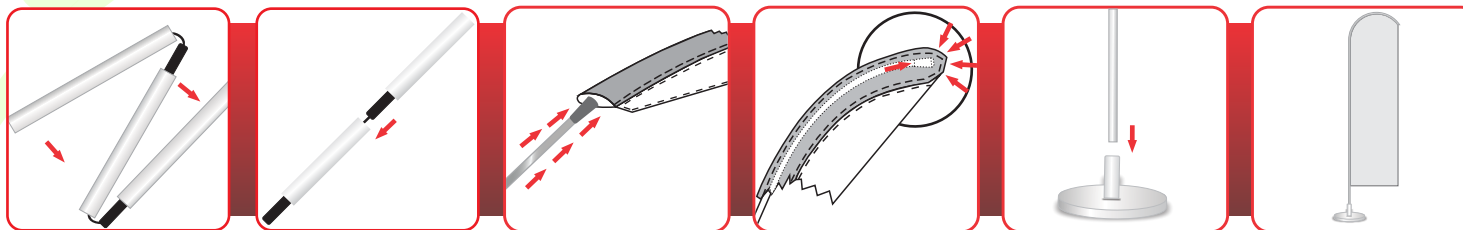

Sucursal: 4 SUR ESQ. CON 21 OTE
NO. 1922 LOCAL 1, COL. EL CARMEN
TEL: (222) 243 11 59

otro punto de vista...



2 Demo Bajo Recto

Descripción

Cuerpo:

Asta de aluminio, base metálica, tela 100% poliéster sublimada.

Accesorios:

Estructura de Aluminio, maleta, sustrato, base para piso o pasto e instructivo

Sustratos:

Lona, Tela flack, Tela sublimada, Tela delgada.

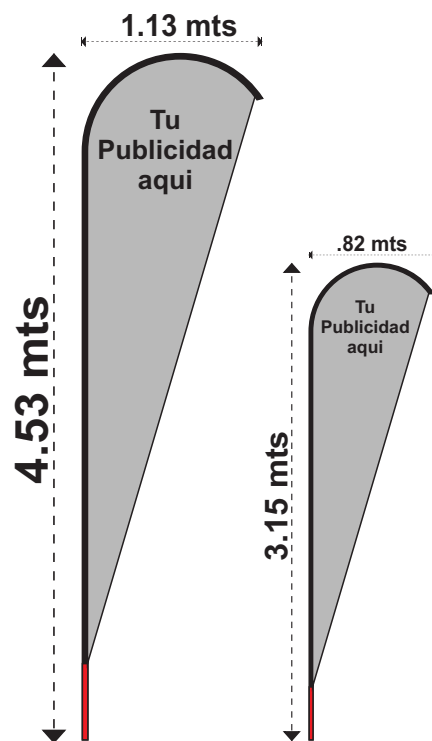
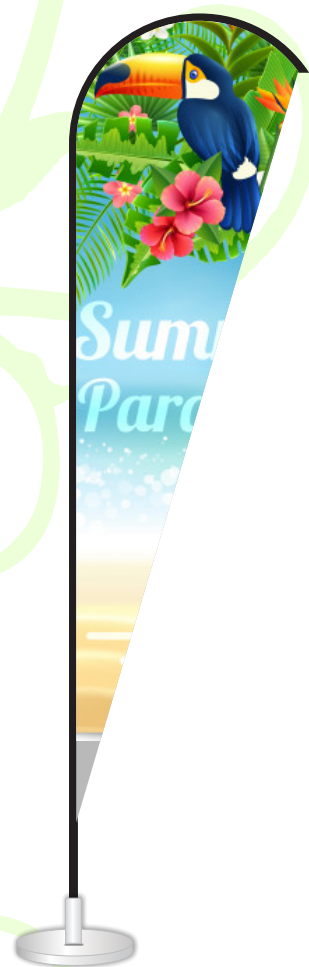

Medidas

Base	Altura
82 cm	315 cm
113 cm	453 cm

Ensamble

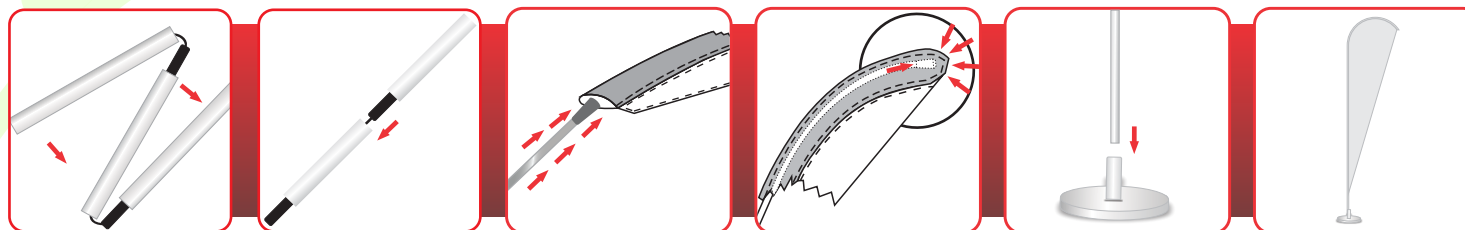

Sucursal: 4 SUR ESQ. CON 21 OTE
NO. 1922 LOCAL 1, COL. EL CARMEN
TEL: (222) 243 11 59

otro punto de vista...



Descripción

Cuerpo:

Asta de aluminio, base metálica, tela 100% poliéster sublimada.

Accesorios:

Estructura de Aluminio, maleta, sustrato, base para piso o pasto e instructivo

Sustratos:

Lona, Tela flack, Tela sublimada, Tela delgada.

4 Demo Medio Flag

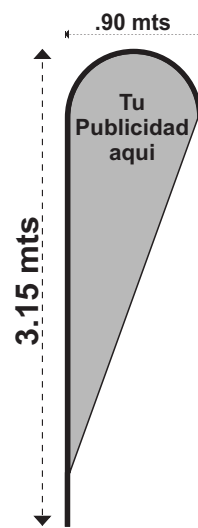
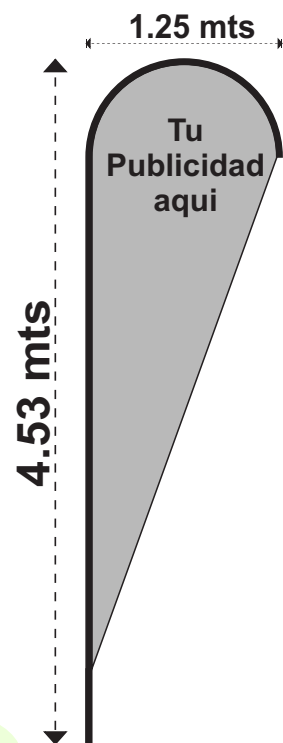

Medidas

Base	Altura
90 cm	315 cm
125 cm	453 cm

Ensamble

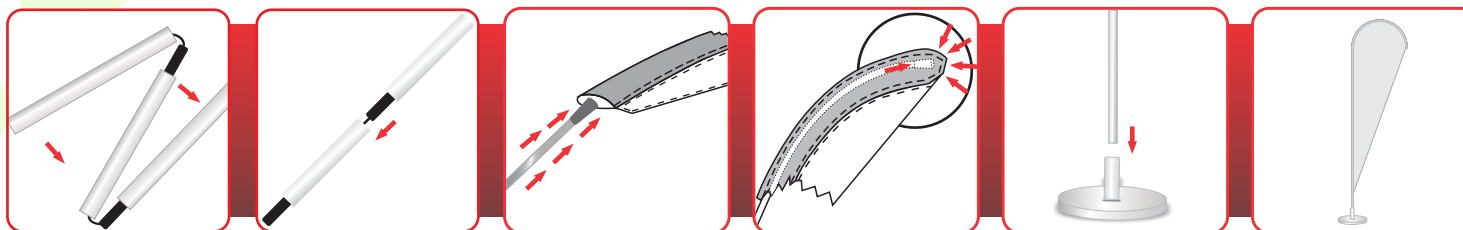

Sucursal: 4 SUR ESQ. CON 21 OTE
NO. 1922 LOCAL 1, COL. EL CARMEN
TEL: (222) 243 11 59

otro punto de vista...



Descripción

Cuerpo:

Asta de aluminio, base metálica, tela 100% poliéster sublimada.

Accesorios:

Estructura de Aluminio, maleta, sustrato, base para piso o pasto e instructivo

Sustratos:

Lona, Tela flack, Tela sublimada, Tela delgada.

5 Demo Velero

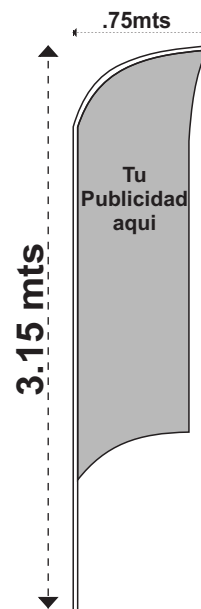
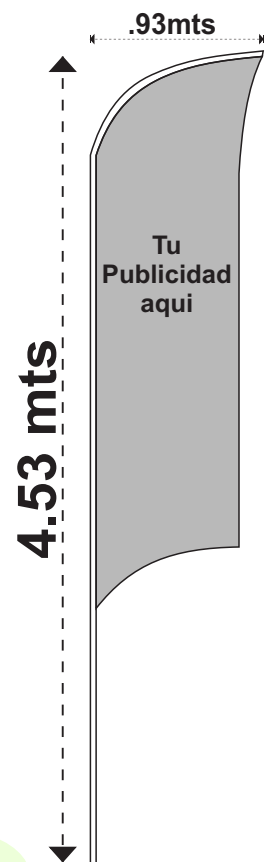

Medidas

Base	Altura
75 cm	315 cm
93 cm	453 cm

Ensamble

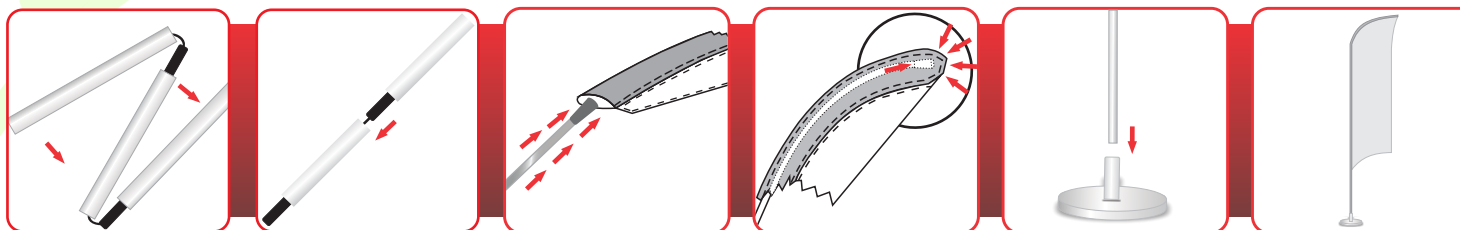

Sucursal: 4 SUR ESQ. CON 21 OTE
NO. 1922 LOCAL 1, COL. EL CARMEN
TEL: (222) 243 11 59

otro punto de vista...



Descripción

Cuerpo:

Asta de aluminio, base metálica, tela 100% poliéster sublimada..

Accesorios:

Estructura de Aluminio, maleta, sustrato, base para piso o pasto e instructivo

Sustratos:

Lona, Tela flack, Tela sublimada, Tela delgada.

Medidas

Base	Altura
90 cm	315 cm
85cm	453 cm

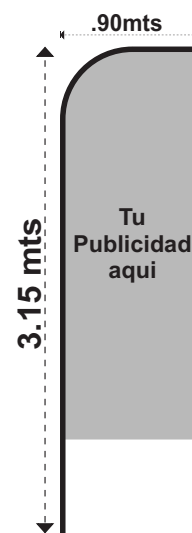

Ensamble

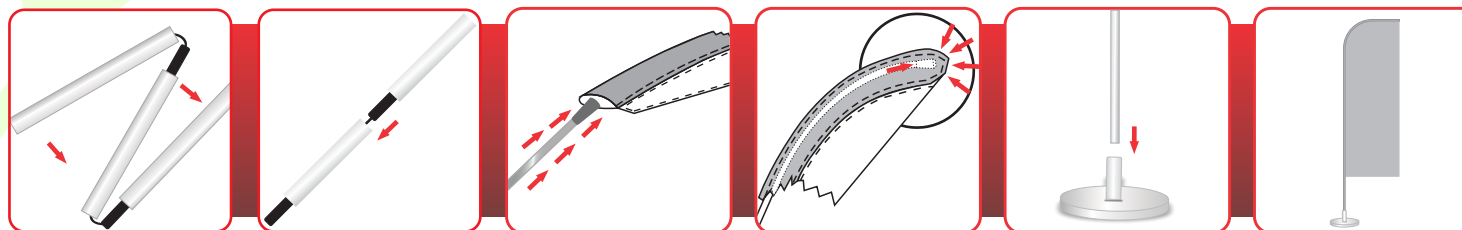

Sucursal: 4 SUR ESQ. CON 21 OTE
NO. 1922 LOCAL 1, COL. EL CARMEN
TEL: (222) 243 11 59

otro punto de vista...



6 Demo Rectangulo Angulo



Descripción

Cuerpo:

Estructura de Metal de alta resistencia
Piezas de unión de acero y aluminio
tela impermeable con protección UV

Accesorios:

Estructura plegable, Postes con altura
vareable

Sustratos:

Toldo, Tela flack

Medidas

Base	Altura
200 cm	200 cm
300 cm	300 cm

**Peso
25 k**

Armado

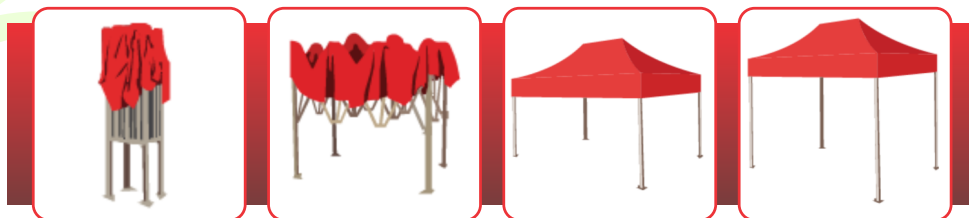

Sucursal: 4 SUR ESQ. CON 21 OTE
NO. 1922 LOCAL 1, COL. EL CARMEN
TEL: (222) 243 11 59

otro punto de vista...





4 SUR ESQ. CON 21 OTE.
NO.1922 LOCAL 1
COLONIA EL CARMEN
TEL: (222) 243 11 59

otro punto de vista...

